

Single Rack Design - Double Sided

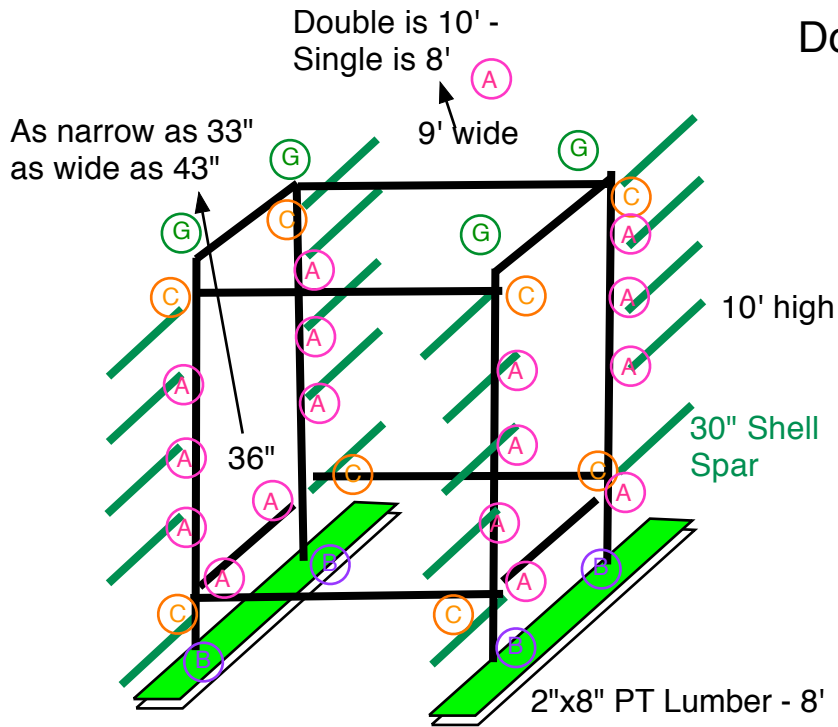

Double Sided Single - BIAC Design

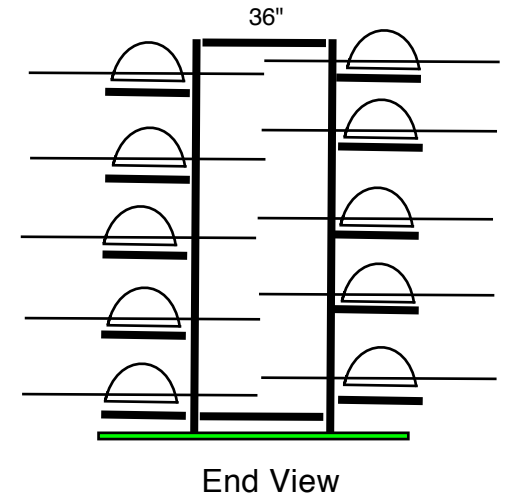
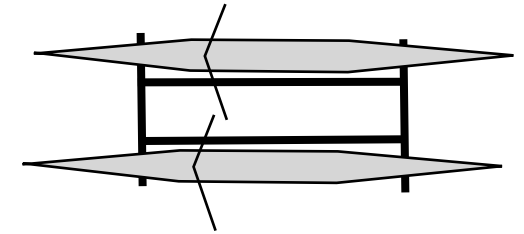
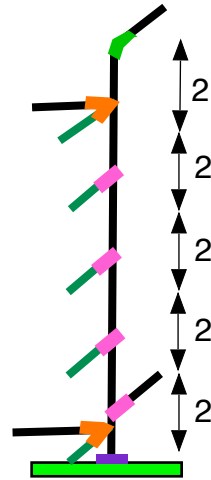

A 16-Single-Socket Tee, Nom Pipe Size 1 1/2 In
Item # 4NXU8



B 4-Base Flange, Nominal Pipe Size 1 1/2 In
Item # 4NXV9



C 8-Side-Outlet Tee, Nom Pipe Size 1 1/2 In
Item # 4NXV4



G 4-Elbow, Nominal Pipe Size 1 1/2 In
Item # 4NXV1



1 1/2" Gavanized Pipe:
4-10' lengths
4-9' lengths
2- 3' lengths
2-5' lengths
18-30" lengths

2- 2"x8" PT lumber 8' long
20 Spar Cushions and wrap
Base screws
Tie down rope

Single Rack Design - Double Sided - flexible size -
can be either 8', 9' or 10' on a side

Double Sided Single - BIAC Design

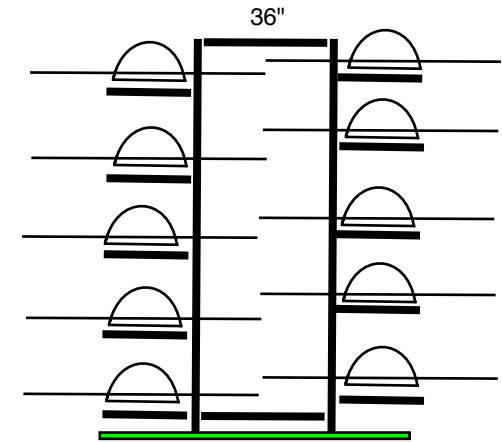
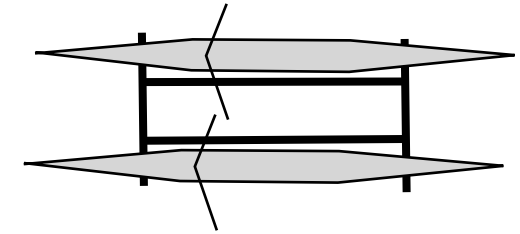
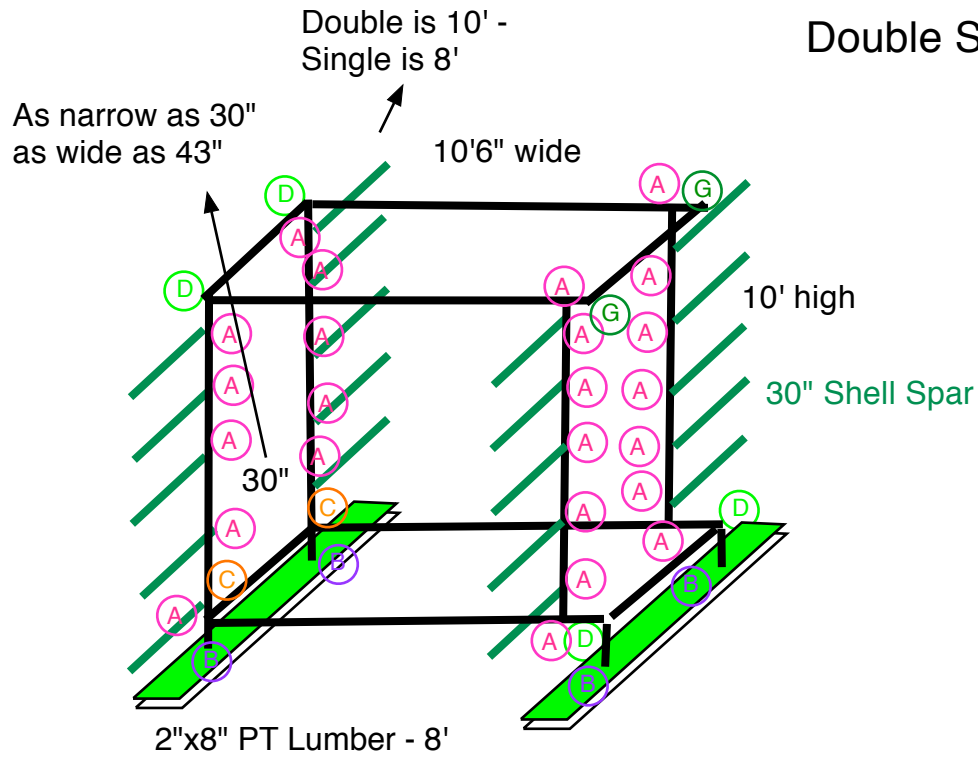

End View

(A) 24-Single-Socket Tee, Nom Pipe Size 1 1/2 In
Item # 4NXU8



(B) 4-Base Flange, Nominal Pipe Size 1 1/2 In
Item # 4NXV9



(C) 2-Side-Outlet Tee, Nom Pipe Size 1 1/2 In
Item # 4NXV4



(D) 4-Side-Outlet Elbow, Nom Pipe
Size 1 1/2 In Item # 4NXV3



(G) 2-Elbow, Nominal Pipe Size 1
1/2 In Item # 4NXV1









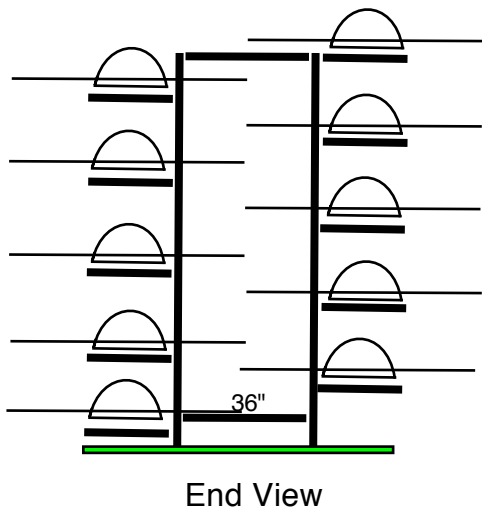
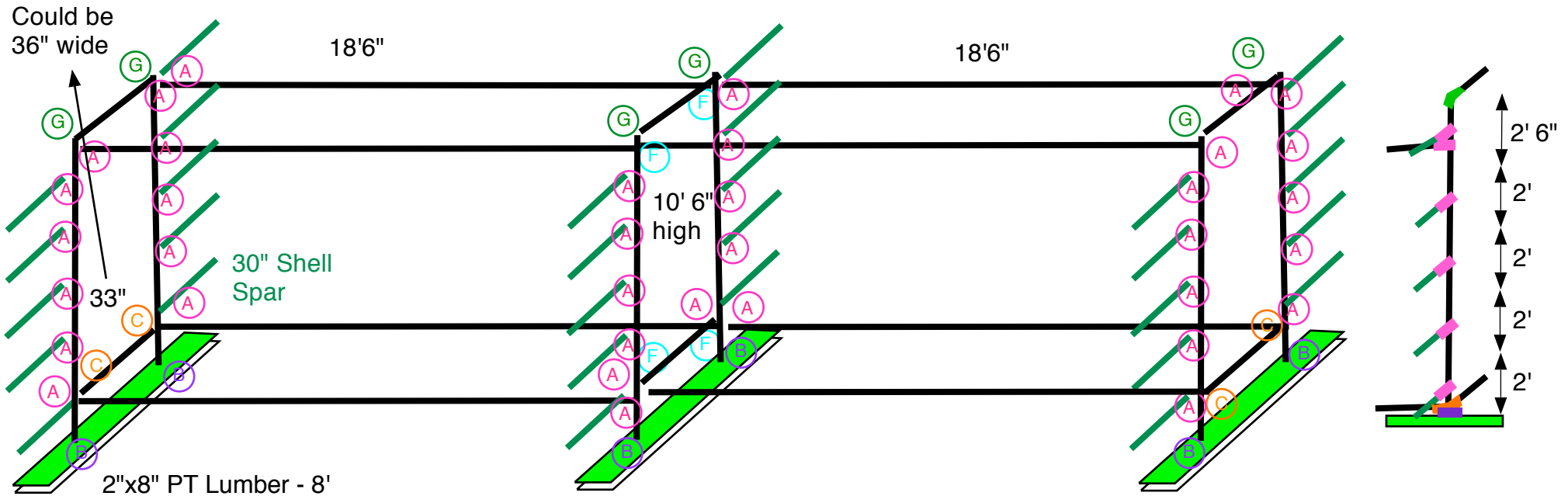

1 1/2" Galvanized Pipe:
6-10'6" lengths
2-10' lengths
4- 3' lengths
20-30" lengths
2-6" lengths

2- 2"x8" PT lumber 8' long
20 Spar Cushions and wrap
Base screws
Tie down rope

<http://www.grainger.com/>

Eight Rack Design - Double Sided



- (A) 36-Single-Socket Tee, Nom Pipe Size 1 1/2 In Item # 4NXU8 
 - (B) 6-Base Flange, Nominal Pipe Size 1 1/2 In Item # 4NXV9 
 - (C) 4-Side-Outlet Tee, Nom Pipe Size 1 1/2 In Item # 4NXV4 
 - (D) 0-Side-Outlet Elbow, Nom Pipe Size 1 1/2 In Item # 4NXV3 
 - (E) 0-Three-Socket Tee, Nom Pipe Size 1 1/2 In Item # 4NXV5 
 - (F) 4-Slip-On Cross, Nom Pipe Size 1 1/2 In Item # 4NXV6 
 - (G) 6-Elbow, Nominal Pipe Size 1 1/2 In Item # 4NXV1 
- 1 1/2" Gavanized Pipe:
 8-18'6" lengths
 6-10'6" lengths
 3- 5' lengths
 6- 33" lengths
 30-30" lengths
- 3- 2"x8" PT lumber 8' long
 30 Spar Cushions and wrap
 Base screws
 Tie down rope

Eight Rack Design - Single Sided
 Eight Rack - four rigged
 8's and 3 unrigged 8's

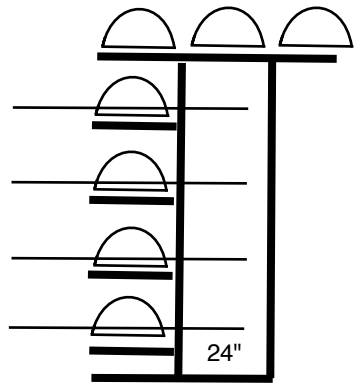
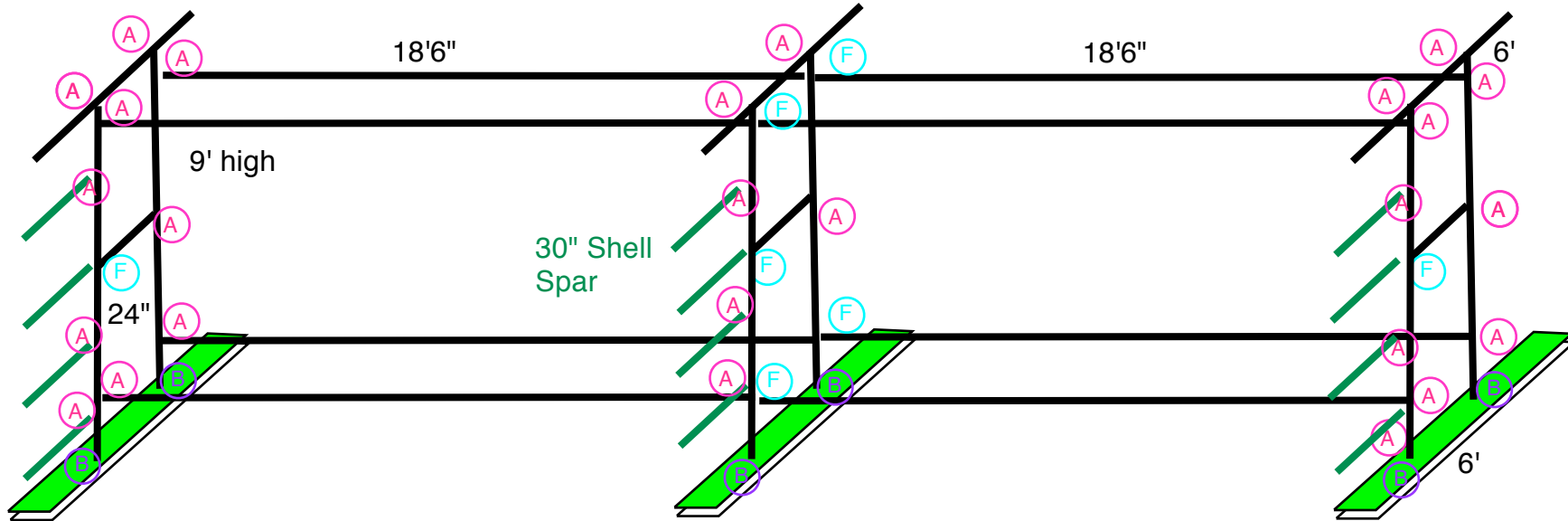
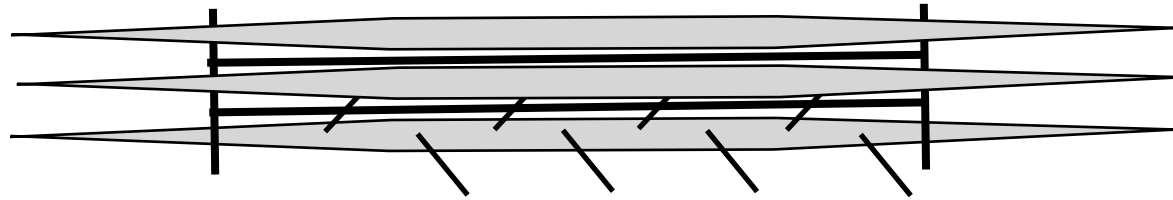

End View

(A) 26-Single-Socket Tee, Nom Pipe Size 1 1/2 In Item # 4NXU8



(F) 7-Slip-On Cross, Nom Pipe Size 1 1/2 In Item # 4NXV6



(B) 6-Base Flange, Nominal Pipe Size 1 1/2 In Item # 4NXV9



1 1/2" Gavanized Pipe:
 8-18'6" lengths
 6-9' lengths
 6-6' lengths
 3- 3' lengths
 12-30" lengths

21 Spar Cushions and wrap
 Base bolts 5" Galvanized
 Tie down ropes